



**ULTIFRESH**  
anti-bacterial & anti-odor



APPAREL CATALOGUE  
2019 | 2020





# LATEST COLLECTION



# ULTIFRESH APPARELS





## ABOUT US

Ultifresh is an Anti-bacterial & Anti-odor brand that produces sustainable & eco-friendly apparels. Our distribution range includes non-decorated blank apparels such as t-shirts polo t-shirts, jackets which are subsequently printed or embroidered with designs and logos.

## FUNCTION

### Remove Bacteria & Odor

- All Ultifresh products have Anti-Bacterial & Anti-Odor technology

### Very Durable

- Lesser bacteria means lesser fabric fibers destroyed

### Saves Water

- Only need to wash after wearing a few times

## ULTIFRESH WHY CHOOSE US

## BENEFITS

### USERS

- Lesser washing required  
- Prevents bacteria from spreading to other clothes when washing

### Environment

- Eco-Friendly  
- Global effort to save water  
- Reduce textile wastage

### Company

- Save costs by providing lesser uniforms

## READY MADE

- Attractive price  
- Fast delivery lead time  
- Internationally certified  
- Minimum order from 1 Piece onwards  
- Standard Asian size chart  
- Up to 25 outstanding and vibrant colors for our basic collections

## SINGAPORE CUSTOM-MADE

### 1. Full Customization

- 5000 fabric selection to choose from  
- Customize own buttons and zips with logo imprinted  
- More than 10 types of fabric treatments  
- More than 19 different types types of logo imprint method  
- Private labels and brands labels customization available

### 2. Specialization

- T-Shirt, polo t-shirt, corporate button shirt, corporate jackets, school jackets, biker jackets, windbreakers, hoodies, overalls, aprons, pants etc

## ABOUT ULTIFRESH

Ultifresh is a patented fabric technology that kills 99.94% bacteria permanently. The anti-bacterial & anti-odor features can be integrated into any fabric without affecting the outlook and the hand feel of the apparel.

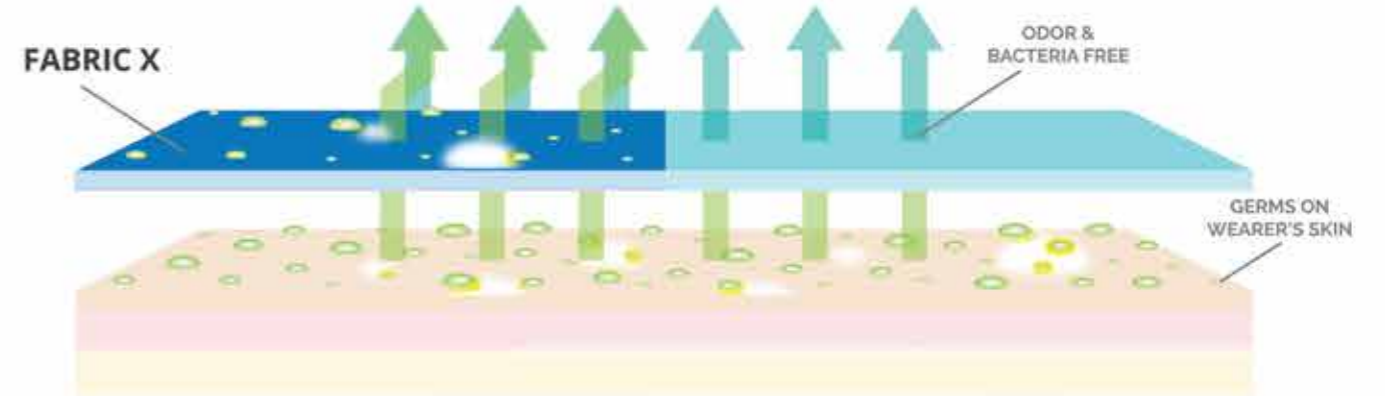

## BENEFITS OF ULTIFRESH

Ultifresh products are designed with copper's anti-microbial properties, allowing it to self-sterilize. It can also prevent bacteria growth, making it a safer apparel for everyone.



### ANTI-ODOR

Ultifresh technology eliminates odor causing germs on the fabric itself, leaving the wearer fresh all day long.



### INCREASED DURABILITY

Ultifresh prevents microbes from living on the apparel. Thus, it increases the longevity of the apparel, resulting into lesser textile wastage each year.



### ANTI-BACTERIAL

We come into contact with thousands of unseen bacteria everyday. Ultifresh fabric solution kills bacteria minutes upon contact.



### SAVES WATER

Ultifresh apparels require lesser wash cycle and water usage up to 75% ! This unique features allows the wearer to save water without compromising safety.



### COST SAVING

Ultifresh lowers the turnover of uniforms and apparels due to its durability, which allows wearer to wear longer without washing



### ECO - FRIENDLY

Ultifresh supports the global Go-Green effort in conserving the Earth's natural resources such as water and reducing textile wastage.



# CONTENT

- Latest Collection ----- 1 - 2
- Why Choose Us ----- 3
- About Ultifresh ----- 4

## 1. Ultifresh Performance Series

- Crew Neck ----- 6 - 11
- Polo T-Shirt ----- 11 - 16

## 2. Ultifresh Design Series

- Raglan Series ----- 17 - 20
- Contrast Series ----- 21 - 32
- Burst Series ----- 33 - 36
- Oriental Series ----- 37 - 40
- Heather Series ----- 41 - 46
- Hybrid Series ----- 47 - 52
- Pique Series ----- 53 - 58

## 3. Ultifresh Outerwear Series

- Bomber Jacket ----- 59 - 60
- Full Moon Zip Up Jacket ----- 61 - 62
- Varsity Jacket ----- 63 - 64

## 4. Essential Series

- Collar Fleece Zip Up Jacket ----- 67 - 70
- Hoodie Without Zip ----- 71 - 72
- Hoodie With Zip ----- 73 - 74
- Jacket In A Bag ----- 75 - 76
- Soft Cardigan ----- 77 - 78
- V Neck Sweater ----- 79 - 80
- Cotton Polo T-Shirt ----- 81 - 82
- Cotton Short Sleeve T-Shirt ----- 83 - 84
- Cotton Shirt Sleeve T-Shirt (Kids) ----- 85
- Polyester Apron ----- 86
- Crew Neck Long Sleeve ----- 87 - 88
- Corporate Wear ----- 89
- Oxford Corporate Shirt ----- 90
- Corporate Unisex Shirt (Long Sleeve) ----- 91 - 92
- Corporate Unisex Shirt (Short Sleeve) ----- 93
- Corporate Female Shirt (Short Sleeve) ----- 94
- Corporate Female Shirt (Long Sleeve) ----- 94
- 2 Button Fitted Blazer ----- 95 - 98

## 5. Customization

- Ultifresh Customization ----- 99 - 100
- Polo T-Shirt Styles ----- 101 - 102
- Jacket Styles ----- 103 - 104
- Buttons Styles ----- 105 - 106
- Zipper Head Styles ----- 106



# ULTIFRESH PERFORMANCE

## CREW NECK T-SHIRT (KIDS CUT)

SIZE	SHOULDER	CHEST	SLEEVE	LENGTH
24	11.5"	25"	4.5"	15.5"
26	12"	27"	5"	17"
28	12.5"	29"	5.5"	18.5"
30	13"	31"	6"	20"
32	13.5"	33"	6.5"	21.5"

Note: Size may varies +/-5% from the above mentioned chart.

- \* 100% Performance Dri-Fit Polyester
- \* Microfiber Polyester Eyelet



- \* 170GSM | 5.01oz (UDF2201)
- \* 160GSM | 4.72oz (THE REST)

## UDF22

### COLORS SELECTION

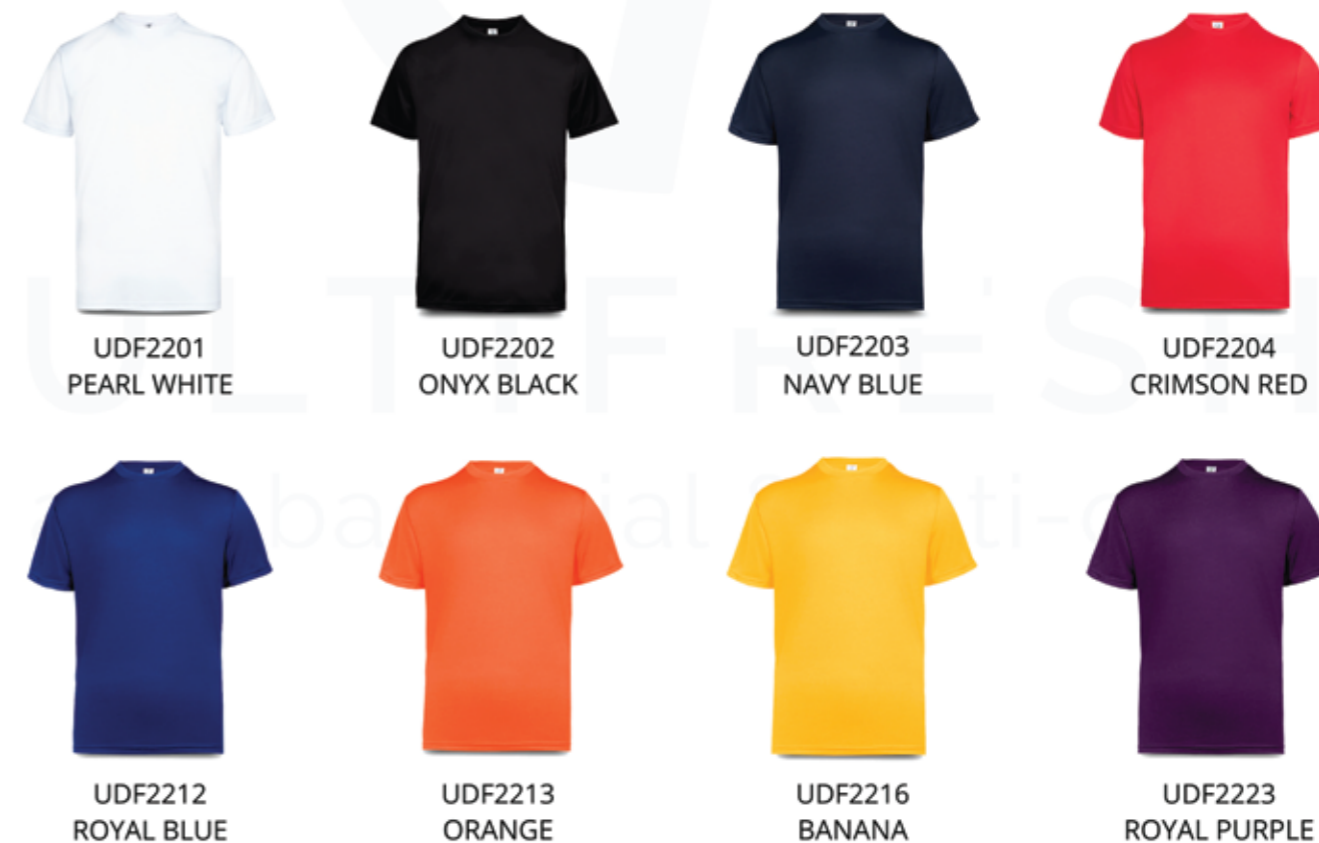





ULTIFRESH 2019  
MODEL: MICHELLE  
— UDF1213 —

ULTIFRESH 2019  
MODEL: FRANCO  
— UDF0123 —



# ULTIFRESH PERFORMANCE

## CREW NECK T-SHIRT (UNISEX)

- \* 100% Performance Dri-Fit Polyester
- \* Microfiber Polyester Eyelet
- \* Anti Bacterial & Anti Odor Finishing
- \* Self Fabric Collar
- \* Eco-Friendly & Water Saving

SIZE	SHOULDER	CHEST	SLEEVE	LENGTH
2XS	15"	34"	7"	25"
XS	16"	36"	7.5"	26"
S	17"	38"	8"	27"
M	18"	40"	8.5"	28"
L	19"	42"	9"	29"
XL	20"	44"	9.5"	30"
2XL	21"	46"	10"	31"
3XL	22"	48"	10.5"	32"

Note: Size may varies +/-5% from the above mentioned chart.

\* 170GSM | 5.01oz (UDF0101)

\* 160GSM | 4.72oz (THE REST)

## UDF01

### COLORS SELECTION

UDF0101 PEARL WHITE	UDF0102 ONYX BLACK	UDF0103 NAVY BLUE	UDF0104 CRIMSON RED	UDF0105 MAROON RED	UDF0106 LIGHT GREY
UDF0107 IRON GREY	UDF0108 TURQUOISE	UDF0109 MAGENTA PINK	UDF0110 LIGHT BLUE	UDF0111 ADMIRAL BLUE	UDF0112 ROYAL BLUE
UDF0113 ORANGE	UDF0114 NEON PINK	UDF0116 BANANA	UDF0117 TUSCAN YELLOW	UDF0118 LIME GREEN	UDF0119 EMERALD GREEN
UDF0120 ARMY GREEN	UDF0121 BASIL GREEN	UDF0122 BARLEY BEIGE	UDF0123 ROYAL PURPLE	UDF0124 NEON YELLOW	UDF0125 NEON ORANGE





# ULTIFRESH PERFORMANCE

## CREW NECK T-SHIRT (FEMALE CUT)



ULTIFRESH 2019  
MODEL: MICHELLE  
UDF1216



- \* 100% Performance Dri-Fit Polyester
- \* Microfiber Polyester Eyelet
- \* **FEMALE** Cutting
- \* Eco-Friendly & Water Saving

SIZE	SHOULDER	CHEST	SLEEVE	LENGTH
S	13"	32"	6"	22.5"
M	14"	34"	6.5"	23.5"
L	15"	36"	6.5"	24.5"
XL	16"	38"	7"	25.5"
2XL	17"	40"	7"	26.5"

Note: Size may varies +/-5% from the above mentioned chart.

\* 170GSM | 5.01oz (UDF1201)

\* 160GSM | 4.72oz (THE REST)



### UDF12 COLORS SELECTION



UDF1201  
PEARL WHITE



UDF1202  
ONYX BLACK



UDF1203  
NAVY BLUE



UD1204  
CRIMSON RED



UDF1212  
ROYAL BLUE



UDF1213  
ORANGE



UDF1216  
BANANA



UD1223  
ROYAL PURPLE





# ULTIFRESH PERFORMANCE

## CREW NECK LONG SLEEVE T-SHIRT (UNISEX)

SIZE	SHOULDER	CHEST	SLEEVE	LENGTH
2XS	15"	34"	26.5"	25"
XS	16"	36"	28"	26"
S	17"	38"	29.5"	27"
M	18"	40"	31"	28"
L	19"	42"	32.5"	29"
XL	20"	44"	33.5"	30"
2XL	21"	46"	34.5"	31"
3XL	22"	48"	35"	32"

Note: Size may varies +/-5% from the above mentioned chart.  
\* 160GSM | 4.72oz

- \* 100% Performance Dri-Fit Polyester
- \* Microfiber Polyester Eyelet
- \* Eco-Friendly & Water Saving



# ULTIFRESH PERFORMANCE

## POLO LONG SLEEVE T-SHIRT (UNISEX)

SIZE	SHOULDER	CHEST	SLEEVE	LENGTH
2XS	15"	34"	26.5"	25"
XS	16"	36"	28"	26"
S	17"	38"	29.5"	27"
M	18"	40"	31"	28"
L	19"	42"	32.5"	29"
XL	20"	44"	33.5"	30"
2XL	21"	46"	34.5"	31"
3XL	22"	48"	35"	32"

Note: Size may varies +/-5% from the above mentioned chart.  
\* 160GSM | 4.72oz

- \* 100% Performance Dri-Fit Polyester
- \* Microfiber Polyester Eyelet
- \* Eco-Friendly & Water Saving

## UDF26

### COLORS SELECTION



UDF2601  
WHITE



UDF2602  
BLACK



UDF2603  
NAVY



UDF2607  
IRON GREY



UDF2613  
ORANGE



UDF2621  
BASIL GREEN

## UDF27

### COLORS SELECTION



UDF2701  
WHITE



UDF2702  
BLACK



UDF2703  
NAVY BLUE



UDF2705  
MAROON



UDF2707  
IRON GREY



UDF2710  
LIGHT BLUE



UDF2712  
ROYAL BLUE



UDF2713  
ORANGE



UDF2721  
BASIL GREEN



ULTIFRESH 2019  
MODEL: ETIENNE  
UDF0508



# ULTIFRESH PERFORMANCE

## POLO T-SHIRT (UNISEX)

- \* 100% Performance Dri-Fit Polyester
- \* Microfiber Polyester Eyelet
- \* Anti Bacterial & Anti Odor Finishing
- \* Matching Collar Rib
- \* Eco-Friendly & Water Saving

SIZE	SHOULDER	CHEST	SLEEVE	LENGTH
2XS	15"	34"	7"	25"
XS	16"	36"	7.5"	26"
S	17"	38"	8"	27"
M	18"	40"	8.5"	28"
L	19"	42"	9"	29"
XL	20"	44"	9.5"	30"
2XL	21"	46"	10"	31"
3XL	22"	48"	10.5"	32"

Note: Size may varies +/-5% from the above mentioned chart.

\* 170GSM | 5.01oz (UDF0101)

\* 160GSM | 4.72oz (THE REST)

## UDF05 COLORS SELECTION





# ULTIFRESH PERFORMANCE

## POLO T-SHIRT (FEMALE CUT)

ULTIFRESH 2019  
MODEL: SANA K  
UD1804



- \* 100% Performance Dri-Fit Polyester
- \* Microfiber Polyester Eyelet
- \* **FEMALE** Cutting
- \* Eco-Friendly & Water Saving

SIZE	SHOULDER	CHEST	SLEEVE	LENGTH
S	13"	32"	6"	22.5"
M	14"	34"	6.5"	23.5"
L	15"	36"	6.5"	24.5"
XL	16"	38"	7"	25.5"
2XL	17"	40"	7"	26.5"

Note: Size may varies +/-5% from the above mentioned chart.

\* 170GSM | 5.01oz (UDF1801)

\* 160GSM | 4.72oz (THE REST)



## UDF18 COLORS SELECTION



UDF1801  
PEARL WHITE



UDF1802  
ONYX BLACK



UDF1803  
NAVY BLUE



UD1804  
CRIMSON RED



UDF1812  
ROYAL BLUE



UDF1813  
ORANGE



UDF1816  
BANANA



UD1823  
ROYAL PURPLE



ULTIFRESH 2019  
MODEL: MICHELLE  
— UDF0304 —

ULTIFRESH 2019  
MODEL: FRANCO  
— UDF0312 —



Contrast Raglan  
Sleeve & Raglan Cut

Anti-Bacterial  
& Anti-Odor  
Finishing



- \* 100% Dri-Fit Polyester
- \* Interlock Weave
- \* Moisture Wicking & Sweat Absorbent
- \* Eco-Friendly & Water Saving

# ULTIFRESH RAGLAN SHORT SLEEVE T-SHIRT

SIZE	CHEST	SLEEVE	LENGTH
2XS	34"	14.5"	25"
XS	36"	15.5"	26"
S	38"	16.5"	27"
M	40"	17.5"	28"
L	42"	18.5"	29"
XL	44"	19.5"	30"
2XL	46"	20.5"	31"
3XL	48"	21.5"	32"

Note: Size may varies +/-5% from the above mentioned chart.

\* 160GSM | 4.72oz

## UDF03 COLORS SELECTION



UDF0312  
WHITE + BLUE



UDF0301  
WHITE + RED



UDF0336  
WHITE + ORANGE



UDF0302  
BLACK + WHITE



UDF0304  
RED + WHITE



UD0316  
YELLOW + WHITE





ULTIFRESH 2019  
MODEL: ETIENNE  
UDF1616



ULTIFRESH 2019  
MODEL: SANA K  
UDF1612

Contrast Raglan  
Sleeve & Raglan Cut

Anti-Bacterial  
& Anti-Odor  
Finishing



BACK  
VIEW

FRONT  
VIEW

# ULTIFRESH RAGLAN

## LONG SLEEVE T-SHIRT

SIZE	CHEST	SLEEVE	LENGTH
2XS	34"	14.5"	25"
XS	36"	15.5"	26"
S	38"	16.5"	27"
M	40"	17.5"	28"
L	42"	18.5"	29"
XL	44"	19.5"	30"
2XL	46"	20.5"	31"
3XL	48"	21.5"	32"

Note: Size may varies +/-5% from the above mentioned chart.

\* 160GSM | 4.72oz

- \* 100% Dri-Fit Polyester
- \* Interlock Weave
- \* Moisture Wicking & Sweat Absorbent
- \* Eco-Friendly & Water Saving

## UDF16 COLORS SELECTION



UDF1612  
WHITE + BLUE



UDF1601  
WHITE + RED



UDF1636  
WHITE + ORANGE



UDF1602  
BLACK + WHITE



UDF1604  
RED + WHITE



UD1616  
YELLOW + WHITE

SGS  
TEST REPORT

intertek  
Total Quality Assured.





ULTIFRESH 2019  
MODEL: FRANCO  
UDF0710



ULTIFRESH 2019  
MODEL: MICHELLE  
UDF0723

Anti-Bacterial  
& Anti-Odor  
Finishing

Contrast  
Collar Rib



BACK  
VIEW

FRONT  
VIEW

- \* 100% Dri-Fit Polyester
- \* Interlock Weave
- \* Moisture Wicking & Sweat Absorbent
- \* Eco-Friendly & Water Saving

# ULTIFRESH CONTRAST

## SIDE PANEL CREW NECK T-SHIRT

SIZE	SHOULDER	CHEST	SLEEVE	LENGTH
2XS	15"	34"	7"	25"
XS	16"	36"	7.5"	26"
S	17"	38"	8"	27"
M	18"	40"	8.5"	28"
L	19"	42"	9"	29"
XL	20"	44"	9.5"	30"
2XL	21"	46"	10"	31"
3XL	22"	48"	10.5"	32"

Note: Size may varies +/-5% from the above mentioned chart.

\* 160GSM | 4.72oz

## UDF07 COLORS SELECTION



UDF0701  
WHITE + ORANGE



UDF0702  
BLACK + WHITE



UDF0703  
NAVY + WHITE



UDF0710  
LIGHT BLUE + WHITE



UDF0723  
PURPLE + WHITE



UDF0733  
BLUE + ORANGE

SGS  
TEST REPORT

intertek  
Total Quality Assured.





ULTIFRESH 2019  
MODEL: MICHELLE  
— UDP0816 —

ULTIFRESH 2019  
MODEL: FRANCO  
— UDP0807 —

Contrast Color Piping with Raglan Sleeve Cut

Anti-Bacterial & Anti-Odor Finishing



- \* 100% Dri-Fit Polyester
- \* Eyelet Weave
- \* Matching Collar Rib
- \* Moisture Wicking & Sweat Absorbent
- \* Eco-Friendly & Water Saving

# ULTIFRESH CONTRAST

## VOV PIPING CREW NECK T-SHIRT

SIZE	CHEST	SLEEVE	LENGTH
2XS	34"	7"	25"
XS	36"	7.5"	26"
S	38"	8"	27"
M	40"	8.5"	28"
L	42"	9"	29"
XL	44"	9.5"	30"
2XL	46"	10"	31"
3XL	48"	10.5"	32"

Note: Size may varies +/-5% from the above mentioned chart.

\* 170GSM | 5.01oz (UDP0801)

\* 160GSM | 4.72oz (THE REST)

## UDP08 COLORS SELECTION



UDP0801  
WHITE + BLACK



UDP0802  
BLACK + RED



UDP0807  
DARK GREY + WHITE



UDP0813  
ORANGE + BLACK



UDP0816  
YELLOW + BLACK



# ULTIFRESH CONTRAST

CS SASH POLO T-SHIRT (UNISEX)

## UDF13 COLORS SELECTION



UDF1301  
WHITE + GREEN  
+ DARK GREY



UDF1302  
BLACK + RED



UDF1306  
LIGHT GREY +  
WHITE + BLUE



UDF1307  
DARK GREY +  
WHITE + BLUE



Anti-Bacterial  
& Anti-Odor  
Finishing

Contrast  
Side Panel



- \* **100% Dri-Fit Polyester**
- \* **Interlock Weave**
- \* **Moisture Wicking & Sweat Absorbent**
- \* **Eco-Friendly & Water Saving**

SIZE	SHOULDER	CHEST	SLEEVE	LENGTH
2XS	15"	34"	7"	25"
XS	16"	36"	7.5"	26"
S	17"	38"	8"	27"
M	18"	40"	8.5"	28"
L	19"	42"	9"	29"
XL	20"	44"	9.5"	30"
2XL	21"	46"	10"	31"
3XL	22"	48"	10.5"	32"

Note: Size may varies +/-5% from the above mentioned chart.

\* 160GSM | 5.64oz



ULTIFRESH 2019  
MODEL: SANA K  
— UDF1906 —

ULTIFRESH 2019  
MODEL: ETIENNE  
— UDF1930 —

Anti-Bacterial  
& Anti-Odor  
Finishing

Contrast  
Shoulder Panel



# ULTIFRESH CONTRAST

## T MAX POLO T-SHIRT (UNISEX)

SIZE	SHOULDER	CHEST	SLEEVE	LENGTH
2XS	15"	34"	7"	25"
XS	16"	36"	7.5"	26"
S	17"	38"	8"	27"
M	18"	40"	8.5"	28"
L	19"	42"	9"	29"
XL	20"	44"	9.5"	30"
2XL	21"	46"	10"	31"
3XL	22"	48"	10.5"	32"

Note: Size may varies +/-5% from the above mentioned chart.

\* 160GSM | 5.64oz

- \* 100% Dri-Fit Polyester
- \* Interlock Weave
- \* Moisture Wicking & Sweat Absorbent
- \* Eco-Friendly & Water Saving

## UDF19 COLORS SELECTION



UDF1902  
BLACK + RED



UDF1906  
GREY + LIGHT BLUE



UDF1912  
ROYAL BLUE + GREY



UDF1930  
GREEN + WHITE





ULTIFRESH 2019  
MODEL: FRANCO  
UDF3301



# ULTIFRESH CONTRAST

## BI-CROSS POLO T-SHIRT (UNISEX)



- \* 100% Dri-Fit Polyester
- \* Interlock Weave
- \* Moisture Wicking & Sweat Absorbent
- \* Eco-Friendly & Water Saving

SIZE	SHOULDER	CHEST	SLEEVE	LENGTH
2XS	15"	34"	7"	25"
XS	16"	36"	7.5"	26"
S	17"	38"	8"	27"
M	18"	40"	8.5"	28"
L	19"	42"	9"	29"
XL	20"	44"	9.5"	30"
2XL	21"	46"	10"	31"
3XL	22"	48"	10.5"	32"

Note: Size may varies +/-5% from the above mentioned chart.

\* 160GSM | 5.64oz



## UDF33 COLORS SELECTION



UDF3301  
WHITE + YELLOW



UDF3302  
BLACK + RED



UDF3303  
NAVY BLUE + WHITE



UDF3307  
GREY + WHITE



UDF3313  
ORANGE + WHITE



UDF3321  
GREEN + WHITE



ULTIFRESH 2019  
MODEL: FRANCO  
— UDF3301 —

ULTIFRESH 2019  
MODEL: MICHELLE  
— UDF4307 —



## UDF43

COLORS SELECTION



UDF4301  
WHITE + YELLOW



UDF4302  
BLACK + RED



UDF4303  
NAVY BLUE + WHITE



UDF4307  
GREY + WHITE



UDF4313  
ORANGE + WHITE



UDF4321  
GREEN + WHITE



# ULTIFRESH CONTRAST

## BI-CROSS POLO T-SHIRT (FEMALE)



- \* 100% Dri-Fit Polyester
- \* **FEMALE** Cutting
- \* Interlock Weave
- \* Moisture Wicking & Sweat Absorbent
- \* Eco-Friendly & Water Saving

SIZE	SHOULDER	CHEST	SLEEVE	LENGTH
S	13"	32"	6"	22.5"
M	14"	34"	6.5"	23.5"
L	15"	36"	6.5"	24.5"
XL	16"	38"	7"	25.5"

Note: Size may varies +/-5% from the above mentioned chart.





ULTIFRESH 2019  
MODEL: SANA K  
— UDF0918 —

ULTIFRESH 2019  
MODEL: ETIENNE  
— UDF0902 —



- \* 100% Dri-Fit Polyester
- \* Matching Collar Rib
- \* Moisture Wicking & Sweat Absorbent
- \* Dual Bind Flat Knitted (Exclusive Fabric)
- \* Eco-Friendly & Water Saving

# ULTIFRESH BURST

## HYPER ALPHA CREW NECK T-SHIRT

SIZE	SHOULDER	CHEST	SLEEVE	LENGTH
2XS	15"	34"	7"	25"
XS	16"	36"	7.5"	26"
S	17"	38"	8"	27"
M	18"	40"	8.5"	28"
L	19"	42"	9"	29"
XL	20"	44"	9.5"	30"
2XL	21"	46"	10"	31"
3XL	22"	48"	10.5"	32"

Note: Size may varies +/-5% from the above mentioned chart.  
\* 140GSM | 4.13oz

### UDF09 COLORS SELECTION



UDF0902  
BLACK + RED



UDF0903  
DARK BLUE + ROYAL BLUE



UDF0907  
DARK GREY + LIGHT GREY



UDF0918  
GREEN + WHITE



UDF0931  
BLACK + YELLOW



UD0932  
BLACK+ NEON ORANGE



# ULTIFRESH BURST

FREEDOM X POLO T-SHIRT (UNISEX)



ULTIFRESH 2019  
MODEL: ETIENNE  
— UDF1512 —

ULTIFRESH 2019  
MODEL: SANA K  
— UDF1502 —

## UDF15 COLORS SELECTION



UDF1501  
WHITE + RED



UDF1502  
BLACK + RED



UDF1503  
NAVY + ROYAL BUE



UDF1512  
ROYAL BLUE + GREY



- \* 100% Dri-Fit Polyester
- \* 3 Button Polo Design
- \* Dual Bind Flat Knitted (Exclusive Fabric)
- \* Moisture Wicking & Sweat Absorbent
- \* Eco-Friendly & Water Saving

SIZE	SHOULDER	CHEST	SLEEVE	LENGTH
2XS	15"	34"	7"	25"
XS	16"	36"	7.5"	26"
S	17"	38"	8"	27"
M	18"	40"	8.5"	28"
L	19"	42"	9"	29"
XL	20"	44"	9.5"	30"
2XL	21"	46"	10"	31"
3XL	22"	48"	10.5"	32"
4XL	23"	50"	11"	33"

Note: Size may varies +/-5% from the above mentioned chart.

\* 140GSM | 4.13oz







ULTIFRESH 2019  
MODEL: FRANCO  
— UDF2013 —

## UDF20

COLORS SELECTION



UDF2001  
WHITE + YELLOW



UDF2002  
BLACK + RED



UDF2003  
DARK BLUE + ROYAL BLUE



UDF2004  
RED + BLACK



UDF2010  
LIGHT BLUE + WHITE



UDF2013  
ORANGE + WHITE



UDF2027  
WHITE + RED

# ULTIFRESH

## ORIENTAL

### ZIP UP COLLAR POLO T-SHIRT



- \* 100% Dri-Fit Polyester
- \* Interlock Weave
- \* Contrast Piping
- \* Moisture Wicking & Sweat Absorbent
- \* Eco-Friendly & Water Saving

SIZE	SHOULDER	CHEST	SLEEVE	LENGTH
2XS	15"	34"	7"	25"
XS	16"	36"	7.5"	26"
S	17"	38"	8"	27"
M	18"	40"	8.5"	28"
L	19"	42"	9"	29"
XL	20"	44"	9.5"	30"
2XL	21"	46"	10"	31"
3XL	22"	48"	10.5"	32"
4XL	23"	50"	11"	33"

Note: Size may varies +/-5% from the above mentioned chart.  
\* 160GSM | 4.72oz







# ULTIFRESH ORIENTAL ZIP UP COLLAR POLO T-SHIRT

SIZE	SHOULDER	CHEST	SLEEVE	LENGTH
S	13"	32"	6"	22.5"
M	14"	34"	6.5"	23.5"
L	15"	36"	6.5"	24.5"
XL	16"	38"	7"	25.5"

Note: Size may vary +/-5% from the above mentioned chart.  
\* 160GSM | 5.64oz

- \* 100% Dri-Fit Polyester
- \* Interlock Weave
- \* **FEMALE** Cutting

- \* Contrast Piping
- \* Moisture Wicking & Sweat Absorbent
- \* Eco-Friendly & Water Saving

## UDF28 COLORS SELECTION



UDF2801  
WHITE + YELLOW



UDF2802  
BLACK + RED



UDF2803  
DARK BLUE + ROYAL BLUE



UDF2804  
RED + BLACK



UDF2810  
LIGHT BLUE + WHITE



UDF2813  
ORANGE + WHITE



UDF2827  
WHITE + RED



# ULTIFRESH HEATHER EDGE CREW NECK T-SHIRT

Anti-Bacterial  
& Anti-Odor  
Finishing

Edge Cut &  
Sewn Design



ULTIFRESH 2019  
MODEL: ETIENNE  
— UDF1706 —

ULTIFRESH 2019  
MODEL: SANA K  
— UDF1710 —



**UDF17**  
COLORS SELECTION

- \* 47% Performance Polyester
- \* 47% Melange Dri-Fit + 6% Spandex
- \* Moisture Wicking & Sweat Absorbent
- \* Eco-Friendly & Water Saving

SIZE	SHOULDER	CHEST	SLEEVE	LENGTH
2XS	15"	34"	7"	25"
XS	16"	36"	7.5"	26"
S	17"	38"	8"	27"
M	18"	40"	8.5"	28"
L	19"	42"	9"	29"
XL	20"	44"	9.5"	30"
2XL	21"	46"	10"	31"
3XL	22"	48"	10.5"	32"

Note: Size may varies +/-5% from the above mentioned chart.

\* 170GSM | 5.01oz



UDF1702  
ONYX BLACK



UDF1703  
NAVY BLUE



UDF1706  
LIGHT GREY



UDF1710  
LIGHT BLUE



UDF1712  
ROYAL BLUE





ULTIFRESH 2019  
MODEL: MICHELLE  
— UFS0106 —

ULTIFRESH 2019  
MODEL: FRANCO  
— USJ0102 —

SGS  
TEST REPORT  
Intertek  
Total Quality. Assured.

Anti-Bacterial  
& Anti-Odor  
Finishing

Regular  
Singlet Cut



- \* 47% Performance Polyester
- \* 47% Melange Dri-Fit + 6% Spandex
- \* Moisture Wicking & Sweat Absorbent
- \* Eco-Friendly & Water Saving

# ULTIFRESH HEATHER

## DRI-FIT SINGLET (UNISEX)

SIZE	SHOULDER	CHEST	LENGTH
XS	11.3"	36"	23.5"
S	11.6"	38"	24.5"
M	11.8"	40"	25.5"
L	12"	42"	26.5"
XL	12.3"	44"	27.5"
2XL	12.6"	46"	28.5"
3XL	12.8"	48"	29.5"

Note: Size may varies +/-5% from the above mentioned chart.

\* 170GSM | 5.01oz

## USJ01

COLORS SELECTION



USJ0102  
ONYX BLACK



USJ0103  
NAVY BLUE



USJ0106  
LIGHT GREY



USJ0110  
LIGHT BLUE



USJ0112  
ROYAL BLUE





ULTIFRESH 2019  
MODEL: MICHELLE  
— UFS0106 —



# ULTIFRESH HEATHER

## DRI-FIT SINGLET (FEMALE)

SIZE	SHOULDER	CHEST	LENGTH
XS	10.6"	34"	22"
S	10.8"	36"	23"
M	11"	38"	24"
L	11.2"	40"	25"

Note: Size may varies +/-5% from the above mentioned chart.

\* 170GSM | 5.01oz

- \* 47% Performance Polyester
- \* 47% Melange Dri-Fit + 6% Spandex
- \* Moisture Wicking & Sweat Absorbent
- \* Eco-Friendly & Water Saving

## UFS01

### COLORS SELECTION



UFS0102  
ONYX BLACK



UFS0103  
NAVY BLUE



UFS0106  
LIGHT GREY



UFS0110  
LIGHT BLUE



UFS0112  
ROYAL BLUE

SGS  
TEST REPORT

intertek  
Total Quality. Assured.



ULTIFRESH 2019  
MODEL: MICHELLE  
UCP1129

ULTIFRESH 2019  
MODEL: FRANCO  
UCP1101



BACK VIEW

FRONT VIEW

- \* 50% Polyester + 50% Cotton
- \* Outer Polyester + Inner Cotton
- \* Moisture Wicking & Sweat Absorbent
- \* Eco-Friendly & Water Saving

# ULTIFRESH HYBRID

## MINIMALIST POLO T-SHIRT (UNISEX)

SIZE	SHOULDER	CHEST	SLEEVE	LENGTH
2XS	15"	34"	7"	25"
XS	16"	36"	7.5"	26"
S	17"	38"	8"	27"
M	18"	40"	8.5"	28"
L	19"	42"	9"	29"
XL	20"	44"	9.5"	30"
2XL	21"	46"	10"	31"
3XL	22"	48"	10.5"	32"

Note: Size may varies +/-5% from the above mentioned chart.  
\* 180GSM | 6.35oz.

## UDF11 COLORS SELECTION



UCP1101  
WHITE + BLACK



UCP1102  
BLACK + WHITE



UCP1103  
NAVY + WHITE



UCP1129  
BLACK + GOLD





# ULTIFRESH HYBRID

## CONTRA POLO T-SHIRT (UNISEX)

Anti-Bacterial  
& Anti-Odor  
Finishing

Contrast Collar  
Rib & Panels



BACK  
VIEW

FRONT  
VIEW

- \* 50% Polyester + 50% Cotton
- \* Outer Polyester + Inner Cotton
- \* Moisture Wicking & Sweat Absorbent
- \* Eco-Friendly & Water Saving

SIZE	SHOULDER	CHEST	SLEEVE	LENGTH
2XS	15"	34"	7"	25"
XS	16"	36"	7.5"	26"
S	17"	38"	8"	27"
M	18"	40"	8.5"	28"
L	19"	42"	9"	29"
XL	20"	44"	9.5"	30"
2XL	21"	46"	10"	31"
3XL	22"	48"	10.5"	32"

Note: Size may varies +/-5% from the above mentioned chart.

\* 190GSM | 6.70oz



## UCP13

### COLORS SELECTION



UCP1301  
WHITE + GREY



UCP1307  
GREY + RED



UCP1310  
LIGHT BLUE + WHITE



UCP1334  
WHITE + GREEN



UCP1335  
WHITE + LIGHT BLUE



ULTIFRESH 2019  
MODEL: MICHELLE  
— UCP2310 —



# ULTIFRESH HYBRID

## CONTRA POLO T-SHIRT (FEMALE)

SIZE	SHOULDER	CHEST	SLEEVE	LENGTH
S	13"	32"	6"	22.5"
M	14"	34"	6.5"	23.5"
L	15"	36"	6.5"	24.5"
XL	16"	38"	7"	25.5"

Note: Size may varies +/-5% from the above mentioned chart.

\* 190GSM | 6.70oz

- \* 50% Polyester + 50% Cotton
- \* **FEMALE** Cutting
- \* Outer Polyester + Inner Cotton

- \* Moisture Wicking & Sweat Absorbent
- \* Eco-Friendly & Water Saving

## UCP23 COLORS SELECTION



UCP2301  
WHITE + GREY



UCP2307  
GREY + RED



UCP2310  
LIGHT BLUE + WHITE



UCP2334  
WHITE + GREEN



UCP2335  
WHITE + LIGHT BLUE





ULTIFRESH 2019  
MODEL: ETIENNE  
— UH0212 —

## UH02

COLORS SELECTION



UH0202  
BLACK



UH0206  
LIGHT GREY



UH0207  
DARK GREY



UH0212  
NAVY BLUE

# ULTIFRESH PIOQUE

## FD TWIN TIPPED POLO T-SHIRT (UNISEX)

Anti-Bacterial  
& Anti-Odor  
Finishing

Double  
Pique Knit



BACK  
VIEW

FRONT  
VIEW



- \* 60% Polyester + 40% Cotton
- \* Dual Stripe Design
- \* Moisture Wicking & Sweat Absorbent
- \* Eco-Friendly & Water Saving

SIZE	SHOULDER	CHEST	SLEEVE	LENGTH
2XS	15"	34"	7"	25"
XS	16"	36"	7.5"	26"
S	17"	38"	8"	27"
M	18"	40"	8.5"	28"
L	19"	42"	9"	29"
XL	20"	44"	9.5"	30"
2XL	21"	46"	10"	31"
3XL	22"	48"	10.5"	32"
4XL	23"	50"	11"	33"

Note: Size may varies +/-5% from the above mentioned chart.

\* 220GSM | 7.76oz





ULTIFRESH 2019  
MODEL: SANA K  
— UDF1206 —



# ULTIFRESH PIOQUE

## FD TWIN TIPPED POLO T-SHIRT (FEMALE)

SIZE	SHOULDER	CHEST	SLEEVE	LENGTH
S	15"	34"	7"	25"
M	16"	36"	7.5"	26"
L	17"	38"	8"	27"
XL	18"	40"	8.5"	28"

Note: Size may varies +/-5% from the above mentioned chart.

\* 220GSM | 7.76oz

- \* 60% Polyester + 40% Cotton
- \* **FEMALE** Cutting
- \* Dual Stripe Design
- \* Moisture Wicking & Sweat Absorbent
- \* Eco-Friendly & Water Saving

## UH12 COLORS SELECTION



UH1202  
BLACK



UH1206  
LIGHT GREY



UH1207  
DARK GREY



UH1212  
NAVY BLUE



ULTIFRESH 2019  
MODEL: SANA K  
UH0330

ULTIFRESH 2019  
MODEL: ETIENNE  
UH0302



Anti-Bacterial & Anti-Odor Finishing

Contrast Mandarin Collar Design



BACK VIEW

FRONT VIEW

- \* 60% Polyester + 40% Cotton
- \* Double Pique Knit
- \* Dual Stripe Design
- \* Moisture Wicking & Sweat Absorbent
- \* Eco-Friendly & Water Saving

# ULTIFRESH PIOQUE

## ACE COLLAR POLO T-SHIRT (UNISEX)

SIZE	SHOULDER	CHEST	SLEEVE	LENGTH
2XS	15"	34"	7"	25"
XS	16"	36"	7.5"	26"
S	17"	38"	8"	27"
M	18"	40"	8.5"	28"
L	19"	42"	9"	29"
XL	20"	44"	9.5"	30"
2XL	21"	46"	10"	31"
3XL	22"	48"	10.5"	32"

Note: Size may varies +/-5% from the above mentioned chart.  
\* 220GSM | 7.76oz

## UH03

COLORS SELECTION



UH0301  
WHITE + NAVY + RED



UH0302  
BLACK + GREY + RED



UH0307  
NAVY + GREY + RED



UH0330  
LIGHT GREY + BLACK + RED



ULTIFRESH 2019  
MODEL: FRANCO  
— UVJ0120 —



ULTIFRESH 2019  
MODEL: MICHELLE  
— UVJ0128 —

Anti-Bacterial  
& Anti-Odor  
Finishing

Matching  
Collar Rib



- \* 100% Performance Dri-Fit Polyester
- \* 100% Polyester Inner Lining
- \* Moisture Wicking & Sweat Absorbent
- \* Eco-Friendly & Water Saving

# ULTIFRESH BOMBER

## ZIP UP JACKET (UNISEX)

SIZE	SHOULDER	CHEST	SLEEVE	LENGTH
2XS	16"	34"	14.5"	25"
XS	17"	36"	15.5"	26"
S	18"	38"	16.5"	27"
M	19"	40"	17.5"	28"
L	20"	42"	18.5"	29"
XL	21"	44"	19.5"	30"
2XL	22"	46"	20.5"	31"
3XL	23"	48"	21.5"	32"
4XL	24"	50"	22.5"	33"

Note: Size may varies +/-5% from the above mentioned chart.  
\* SHELL - 55GSM | 1.94oz  
\* INNER - 160GSM | 5.64oz

## UVJ01 COLORS SELECTION



UVJ0102  
BLACK



UVJ0103  
NAVY



UVJ0105  
MAROON



UVJ0120  
OLIVE



UVJ0128  
ORANGE



ULTIFRESH 2019  
MODEL: SANA K  
— UVJ0307 —



ULTIFRESH 2019  
MODEL: ETIENNE  
— UVJ0303 —



- \* 92% Polyester + 8% Spandex
- \* Side Zip Pockets
- \* Matching Collar Rib
- \* Moisture Wicking & Sweat Absorbent
- \* Eco-Friendly & Water Saving

# ULTIFRESH FULL MOON

## ZIP UP JACKET (UNISEX)

SIZE	SHOULDER	CHEST	SLEEVE	LENGTH
2XS	16"	37"	21.5"	25"
XS	17"	39"	22.5"	26"
S	18"	41"	23.5"	27"
M	18.5"	43"	24"	28"
L	19"	45"	25"	29"
XL	20"	47"	25.5"	30"
2XL	21"	49"	26.5"	31"
3XL	22"	51"	27"	32"
4XL	23"	53"	27.5"	33"

Note: Size may varies +/-5% from the above mentioned chart.  
\* 280GSM | 8.26oz

## UVJ03 COLORS SELECTION



UVJ0302  
BLACK



UVJ0303  
NAVY



UVJ0307  
LIGHT GREY



ULTIFRESH 2019  
MODEL: ETIENNE  
UVJ0512



ULTIFRESH 2019  
MODEL: SANA K  
UVJ0526

Anti-Bacterial  
& Anti-Odor  
Finishing

Double Striped Rib  
(Sleeve, Collar & Hem)



- \* 92% Polyester + 8% Spandex
- \* Color Matching Matt Button
- \* 2 Front Pockets
- \* Moisture Wicking & Sweat Absorbent
- \* Eco-Friendly & Water Saving

# ULTIFRESH VARSITY JACKET

SIZE	SHOULDER	CHEST	SLEEVE	LENGTH
2XS	16"	34"	21"	25"
XS	16.5"	36"	22"	26"
S	17"	38"	22.5"	27"
M	17.5"	40"	23.5"	28"
L	18"	42"	24"	29"
XL	18.5"	44"	25"	30"
2XL	19"	46"	25.5"	31"
3XL	19.5"	48"	27.5"	32"
4XL	20"	50"	28"	33"

Note: Size may varies +/-5% from the above mentioned chart.

\* 280GSM | 8.26oz

## UVJ05 COLORS SELECTION



UVJ0502  
BLACK + WHITE



UVJ0503  
NAVY BLUE + WHITE



UVJ0504  
CRIMSON RED + WHITE



UVJ0512  
ROYAL BLUE + WHITE



UVJ0526  
BLACK + RED



# READY STOCK ESSENTIALS

MINIMALISM  
IS NOT A STYLE,  
IT IS AN ATTITUDE,  
A WAY OF BEING.

C. SILVESTRIN



**COLLAR FLEECE  
ZIP UP JACKET (UNISEX)**



ULTIFRESH 2019  
MODEL: FRANCO  
— OWC4512 —



SIZE	WAIST	CHEST	SLEEVE	LENGTH
S	43"	42"	23"	25"
M	44"	44"	24"	26"
L	46"	45"	25"	26"
XL	47"	47"	26"	27"
2XL	49"	48"	26"	28"
3XL	50"	50"	27"	29"

Note: Size may varies +/-5% from the above mentioned chart.

\* 280GSM | 8.20oz

- **100% Polyester Reverse Dual Sided Fleece**
- **Full Zip Stand Up Collar**
- **Elastic Sleeve End**
- **Zip On Both Sided Pocket**
- **Elastic Cord At Hem For Hem Adjustment**

**OWC45**  
COLORS SELECTION



OWC4502  
ONYX BLACK



OWC4504  
CRIMSON RED



OWC4512  
ROYAL BLUE

READY STOCK  
ESSENTIALS





ULTIFRESH 2019  
MODEL: MICHELLE  
— OWC5504 —

READY STOCK  
ESSENTIALS

**BEAM**  
QUALITY APPAREL  
**COLLAR FLEECE**  
**ZIP UP JACKET (FEMALE)**



SIZE	WAIST	CHEST	SLEEVE	LENGTH
S	37"	35"	22"	23"
M	39"	36"	23"	24"
L	40"	38"	23"	25"
XL	42"	39"	24"	26"
2XL	43"	41"	24"	26"
3XL	45"	43"	25"	27"

Note: Size may varies +/-5% from the above mentioned chart.

\* 280GSM | 8.20oz

- **100% Polyester Reverse Dual Sided Fleece**
- **FEMALE** Cutting
- Full Zip Stand Up Collar
- Elastic Sleeve End
- Zip On Both Sided Pocket
- Elastic Cord At Hem For Hem Adjustment

**OWC55**  
COLORS SELECTION



OWC5502  
ONYX BLACK



OWC5504  
CRIMSON RED



OWC5512  
ROYAL BLUE





ULTIFRESH 2019  
MODEL: ETIENNE  
— HDR3004 —

READY STOCK  
ESSENTIALS

Unlined Hood With  
Matching Drawstring



- Polyester / Cotton Blend
- Kangaroo Pockets With Ribbed Finishing
- Double Needle Cuffs And Waistband For Extra Durability.

**BEAM**  
QUALITY APPAREL  
**HOODIE  
WITHOUT ZIP**

SIZE	SHOULDER	CHEST	SLEEVE	LENGTH
2XS	15"	34"	23"	25"
XS	16"	36"	24.5"	25.5"
S	17"	38"	24.5"	26"
M	18"	41"	25"	27.5"
L	18.5"	43"	26"	29"
XL	19"	46"	27"	30"
2XL	20"	48"	27.5"	31"
3XL	21"	50"	28"	32"
4XL	21.5"	52"	29"	33"

Note: Size may varies +/-5% from the above mentioned chart.  
\* 220GSM | 6.50oz

**HDR30**  
COLORS SELECTION



HDR3001  
PEARL WHITE



HDR3002  
ONYX BLACK



HDR3003  
NAVY BLUE



HDR3004  
CRIMSON RED



HDR3006  
LIGHT GREY





ULTIFRESH 2019  
MODEL: FRANCO  
HDR4002

READY STOCK  
ESSENTIALS

Unlined Hood With  
Matching Drawstring



- Polyester / Cotton Blend
- Pouch Pockets
- Matching Zip
- Double Needle Cuffs And Waistband For Extra Durability

**BEAM**  
QUALITY APPAREL  
**HOODIE  
WITH ZIP**

SIZE	SHOULDER	CHEST	SLEEVE	LENGTH
2XS	15"	34"	23"	25"
XS	16"	36"	24.5"	25.5"
S	17"	38"	24.5"	26"
M	18"	41"	25"	27.5"
L	18.5"	43"	26"	29"
XL	19"	46"	27"	30"
2XL	20"	48"	27.5"	31"
3XL	21"	50"	28"	32"
4XL	21.5"	52"	29"	33"

Note: Size may varies +/-5% from the above mentioned chart.  
\* 220GSM | 6.50oz

**HDR40**

COLORS SELECTION



HDR4001  
PEARL WHITE



HDR4002  
ONYX BLACK



HDR4003  
NAVY BLUE



HDR4004  
CRIMSON RED



HDR4006  
LIGHT GREY



ULTIFRESH 2019  
MODEL: FRANCO  
— AKJ0102 —



ULTIFRESH 2019  
MODEL: MICHELLE  
— AKJ0104 —



READY STOCK  
ESSENTIALS



Unique printed patterns

- 100% Light Weight Polyester
- UPF40 + Coating
- Fully Sewn Built In Hoodie Design
- Packable Drawstring Bag Included
- Come with Unique Pattern Prints in Front Panel

**LIGHTWEIGHT  
MICROFIBER**

**JACKET IN A BAG (PACKABLE)**

SIZE	SHOULDER	CHEST	SLEEVE	LENGTH
S	-"	20"	27.5"	25"
M	-"	20.5"	28.5"	26"
L	-"	21.5"	29"	26.5"
XL	-"	22"	30"	27"
2XL	-"	23"	31"	28"
3XL	-"	24"	31.5"	29"
4XL	-"	24.5"	32.5"	29.5"

Note: Size may varies +/-5% from the above mentioned chart.



**AKJ01**  
COLORS SELECTION



AKJ0101  
BLACK



AKJ0102  
ROYAL BLUE



AKJ0103  
LIME GREEN



AKJ0104  
ORANGE



AKJ0105  
YELLOW



AKJ0106  
SKY BLUE



AKJ0107  
RED



AKJ0108  
BRIGHT PINK



AKJ0110  
PINK



AKJ0111  
WHITE



**CLASSIC  
SOFT CARDIGAN**

ULTIFRESH 2019  
MODEL: SANA K  
— ARC1006 —

ULTIFRESH 2019  
MODEL: ETIENNE  
— ARC1001 —



SIZE	SHOULDER	CHEST	SLEEVE	LENGTH
XS	16"	36"	7.5"	26"
S	17"	38"	8"	27"
M	18"	40"	8.5"	28"
L	19"	42"	9"	29"
XL	20"	44"	9.5"	30"
2XL	21"	46"	10"	31"
3XL	22"	48"	10.5"	32"
5XL	24"	52"	11.5"	34"

Note: Size may varies +/-5% from the above mentioned chart.

\* 130GSM | 8.88oz

**ARC01**  
COLORS SELECTION



ARC1001  
DARK GREY



ARC1002  
NAVY BLUE



ARC1003  
GREEN



ARC1004  
BLACK



ARC1005  
BROWN



ARC1006  
MAROON

READY STOCK  
ESSENTIALS





ULTIFRESH 2019  
MODEL: FRANCO  
ARS1005

READY STOCK  
ESSENTIALS

**BEAM**  
QUALITY APPAREL  
**CLASSIC  
V-NECK SWEATER**

SIZE	SHOULDER	CHEST	SLEEVE	LENGTH
XS	16"	36"	7.5"	26"
S	17"	38"	8"	27"
M	18"	40"	8.5"	28"
L	19"	42"	9"	29"
XL	20"	44"	9.5"	30"
2XL	21"	46"	10"	31"
3XL	22"	48"	10.5"	32"
5XL	24"	52"	11.5"	34"

Note: Size may varies +/-5% from the above mentioned chart.

\* 130GSM | 8.88oz



- \* Matching Rib
- \* 100% Cotton
- \* Fitted Cut

**ARS01**  
COLORS SELECTION



ARS1001  
DARK GREY



ARS1002  
NAVY BLUE



ARS1003  
GREEN



ARS1004  
BLACK



ARS1005  
BROWN



ARS1006  
MAROON





ULTIFRESH 2019  
MODEL: SANA K  
UPT01-05



ULTIFRESH 2019  
MODEL: ETIENNE  
UPT01-40

READY STOCK  
ESSENTIALS

**POLO T-SHIRT  
(UNISEX)**

- 100% Premium "LACOSTE" Fabric
- Matching Color Button
- Matching Ribbed Collar & Cuffs
- Available In 15 Colors
- XS - 3XL Size
- All Ready Stock

SIZE	SHOULDER	CHEST	SLEEVE	LENGTH
XS	15"	18"	8"	26"
S	16"	19"	8.5"	27"
M	18"	20"	8.5"	28"
L	18"	20.5"	9"	29"
XL	19"	21"	9"	30"
2XL	20"	22"	9.5"	30.5"
3XL	21"	24"	9.5"	31"

Note: Size may varies +/-5% from the above mentioned chart.  
\* 220GSM



**UPT01**  
COLORS SELECTION





ULTIFRESH 2019  
MODEL: FRANCO  
USS01-05



ULTIFRESH 2019  
MODEL: MICHELLE  
USS01-17



READY STOCK  
ESSENTIALS

## SHORT SLEEVE T-SHIRT (UNISEX)

- **100% Premium Cotton (Unisex)**
- **Matching Ribbed Collar**
- **Available In 18 Colors**
- **XS - 5XL Size**
- **All Ready Stock**

SIZE	SHOULDER	CHEST	SLEEVE	LENGTH
XS	15"	18"	7"	26"
S	17"	19"	7.5"	27"
M	18"	20"	7.5"	28"
L	19"	21"	8"	29"
XL	20"	22"	8"	30"
2XL	20.5"	23"	8.5"	31"
3XL	22"	24"	8.5"	31.5"
4XL	23"	25"	9"	32"
5XL	24"	26"	9.5"	33"

Note: Size may varies +/-5% from the above mentioned chart.

\* 170GSM - 175GSM



## USS01 COLORS SELECTION





# BEAM

QUALITY APPAREL

## SHORT SLEEVE T-SHIRT (KIDS)

- 100% Premium Cotton
- Matching Ribbed Collar
- Available In 15 Colors
- 2/4 years - 13/14 years
- All Ready Stock

SIZE	SHOULDER	CHEST	SLEEVE	LENGTH
24	11"	12"	5"	17"
26	12"	13"	6"	18"
28	13"	14"	6.5"	20"
30	15"	15"	6.5"	21"
32	15"	17"	7"	23"
34	17"	18"	7"	24"

Note: Size may varies +/-5% from the above mentioned chart.

\* 170GSM - 175GSM



## KSS01

COLORS SELECTION



KSS01-01  
WHITE



KSS01-02  
BLACK



KSS01-03  
NAVY BLUE



KSS01-05  
MAROON



KSS01-12  
ROYAL BLUE



KSS01-13  
ORANGE



KSS01-17  
YELLOW



KSS01-18  
LIME GREEN



KSS01-23  
PURPLE



KSS01-39  
INDIGO BLUE



KSS01-40  
BOTTLE GREEN



KSS01-41  
OLIVE



KSS01-44  
AQUA



KSS01-45  
FUSCHIA



KSS01-46  
KELLY GREEN

# BEAM

QUALITY APPAREL

## APRON

### 100% POLYESTER

- 100% Polyester
- Back Lace Design
- Front Pockets
- Customizable
- Available In 10 Colors
- Free Size
- All Ready Stock

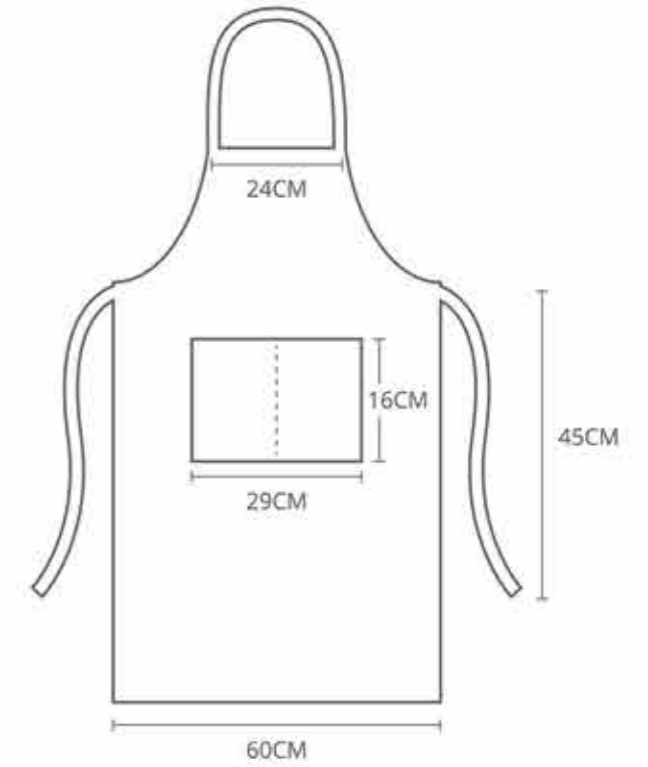

Note: dimension may vary +/- 5% from the above mentioned chart.

## APR10

COLORS SELECTION



APR101  
BURGUNDY



APR102  
ORANGE



APR103  
PEARL WHITE



APR104  
SKY BLUE



APR105  
LIME GREEN



APR1061  
ROSE PINK



APR107  
YELLOW



APR108  
BLACK



APR109  
COFFEE



APR110  
RED





ULTIFRESH 2019  
MODEL: FRANCO  
RGN2101

READY STOCK  
ESSENTIALS

**CREW NECK  
LONG SLEEVE**



- Poly/Cotton Blend
- Crew Neck, Long Sleeve Design
- 6 Available Colors
- Double needle cuffs and waistband for extra durability

SIZE	SHOULDER	CHEST	SLEEVE	LENGTH
XXS	15"	34"	-"	25"
XS	16"	36"	-"	26"
S	17"	39"	-"	26"
M	18"	41"	-"	28"
L	19"	43"	-"	29"
XL	19"	46"	-"	30"
2XL	20"	48"	-"	31"
3XL	21"	50"	-"	32"
4XL	22"	53"	-"	33"

Note: Size may varies +/-5% from the above mentioned chart.  
\* 220GSM | 6.50oz

**RGN21**  
COLORS SELECTION



RGN2101  
PEARL WHITE



RGN2102  
ONYX BLACK



RGN2103  
NAVY BLUE



RGN2104  
CRIMSON RED



RGN2106  
LIGHT GREY



RGN2138  
LIGHT PINK



**FEMALE SHORT  
& LONG SLEEVE  
CORPORATE SHIRT**  
*Quality Apparels*



**BEAM**  
QUALITY APPAREL

**OXFORD  
CORPORATE  
SHIRT**



- Made of 60% Cotton 40% Oxford Fabric
- Hidden Buttons Behind Collar For An Alternate Look.
- One Chest Pocket On The Left
- Off White Full Placket Buttons

SIZE	SHOULDER	CHEST	SLEEVE	LENGTH
S(38)	17"	38"	24"	28"
M(39)	17"	39"	24"	29"
L(40)	18"	41"	25"	30"
XL(41)	19"	43"	25"	30"
2XL(42)	19"	44"	25"	30"
3XL(43)	20"	47"	25"	31"
4XL(44)	20"	49"	25"	31"

Note: Size may varies +/-5% from the above mentioned chart.

**FLT3**  
COLORS SELECTION



FTL301  
PEARL WHITE



FTL303  
NAVY BLUE



FLT306  
LIGHT GREY



FT310  
LIGHT BLUE



FT338  
LIGHT PINK



FT340  
LAKE BLUE



ULTIFRESH 2019  
MODEL: ETIENNE  
ACS110

ULTIFRESH 2019  
MODEL: SANA K  
FTL138



Black piping available for  
ACS 108 & ACS 109  
Only



- 40% Cotton + 60% Polyester Fabric
- Moisture Wick & Anti Wrinkle Technology
- V-Edge Collar Design with Iron Fusing
- Full Placket Buttons
- One Chest Pocket On The Left
- With Poplin / With Twill Finishing

**BEAM**  
QUALITY APPAREL  
**HIGHT QUALITY  
CORPORATE  
UNISEX SHIRT**

SIZE	SHOULDER	CHEST	SLEEVE	LENGTH
S(38)	16.5"	37"	23"	28"
M(39)	17"	38"	23"	28"
L(40)	18"	39"	23.5"	28.5"
XL(41)	18"	41"	24"	29"
2XL(42)	18.5"	43"	24"	30"
3XL(43)	19.5"	44"	24.5"	31"
4XL(44)	20.5"	47"	25"	32"

Note: Size may varies +/-5% from the above mentioned chart.  
\* 220GSM | 6.50oz.

**ACS10 /11**  
COLORS SELECTION

POPLIN FINISHING



ACS110  
MAROON RED



ACS111  
BLACK



ACS112  
LIGHT PINK



ACS113  
LIGHT BLUE



ACS114  
WHITE

TWILL FINISHING



ACS100  
WHITE



ACS102  
BLACK



ACS103  
LIGHT BLUE



ACS107  
LIGHT PURPLE



ACS108  
LIGHT BLUE



ACS109  
WHITE

READY STOCK  
ESSENTIALS



ULTIFRESH 2019  
MODEL: ETIENNE  
TCS101



**TWILL FINISHING - UNISEX SHORT SLEEVE**

SIZE	SHOULDER	CHEST	SLEEVE	LENGTH
S(38)	16.5"	37"	8"	28"
M(39)	17"	38"	8"	28"
L(40)	18"	39"	8.5"	28.5"
XL(41)	18"	41"	8.5"	29"
2XL(42)	18.5"	43"	9"	30"
3XL(43)	19.5"	44"	9"	31"
4XL(44)	20.5"	47"	9.5"	32"

Note: Size may varies +/-5% from the above mentioned chart.

**TCS1**  
COLORS SELECTION



TCS 101  
WHITE



TCS 102  
BLACK



TCS 110  
LIGHT BLUE



TCS 138  
PINK



TCS 123  
PURPLE



TCS 110(A)  
LIGHT BLUE  
(CHECKERED)

**BEAM**  
QUALITY APPAREL



**TWILL FINISHING - FEMALE CUT SHORT SLEEVE**

SIZE	SHOULDER	CHEST	SLEEVE	LENGTH
XS(35)	14.5"	35"	7.5"	22.5"
S(36)	15"	37"	7.5"	23"
M(37)	15.5"	38"	7.5"	23.5"
L(38)	16"	40"	8"	24"
XL(39)	16"	41"	8"	25"
2XL(40)	16.5"	42"	8.5"	25.5"
3XL(41)	17"	44"	8.5"	26"
5XL(42)	17.5"	47"	9"	27"

Note: Size may varies +/-5% from the above mentioned chart.



FTS 101  
WHITE



FTS 102  
BLACK



FTS 110  
LIGHT BLUE



**TWILL FINISHING - FEMALE CUT LONG SLEEVE**

SIZE	SHOULDER	CHEST	SLEEVE	LENGTH
XS(35)	14.5"	35"	21"	22.5"
S(36)	15"	37"	21"	23"
M(37)	15.5"	38"	21.5"	23.5"
L(38)	16"	40"	21.5"	24"
XL(39)	16"	41"	22"	25"
2XL(40)	16.5"	42"	22.5"	25.5"
3XL(41)	17"	44"	23"	26"
5XL(42)	17.5"	47"	23.5"	27"

Note: Size may varies +/-5% from the above mentioned chart.



FTL 101  
WHITE



FTL 110  
LIGHT BLUE



FTL 138  
PINK

READY STOCK  
ESSENTIALS





ULTIFRESH 2019  
MODEL: ETIENNE  
— CBM3503 —

— PAT0103 —

READY STOCK  
ESSENTIALS



CBM3502  
BLACK

CBM3503  
NAVY BLUE

- 65% Polyester 35% Rayon
- (Shell) 100% Polyester
- 3 Pocket Flat Collar Design
- Full Suit Available
- Dual Buttons

**PREMIUM**

**2 BUTTON FITTED BLAZER  
(MALE CUTTING)**

**JACKET SIZE CHART**

SIZE	SHOULDER	CHEST	SLEEVE	LENGTH
165/S	16.5"	37"	23"	28"
170/M	17"	38"	23"	28"
175/L	18"	39"	23.5"	28.5"
180/XL	18"	41"	24"	29"
185/2XL	18.5"	43"	24"	30"
190/3XL	19.5"	44"	24.5"	31"

Note: Size may varies +/-5% from the above mentioned chart.



PAT0102  
BLACK

PAT0103  
NAVY BLUE

**PANT SIZE CHART**

SIZE	WAIST	HIP	LENGTH
165/S	30.3"	37.4"	40.2"
170/M	31.5"	38.6"	40.9"
175/L	32.7"	39.8"	41.7"
180/XL	34.2"	41.3"	42.5"
185/2XL	35.8"	42.9"	42.5"
190/3XL	37.4"	44.5"	42.5"

Note: Size may varies +/-5% from the above mentioned chart.







ULTIFRESH 2019  
MODEL: SANA K  
CBM2503

SKT0202

READY STOCK  
ESSENTIALS



CBM2502  
BLACK

CBM2503  
NAVY BLUE

- 65% Polyester 35% Rayon
- (Shell) 100% Polyester
- 3 Pocket Flat Collar Design
- Full Suit Available
- Dual Buttons

**PREMIUM**

**2 BUTTON FITTED BLAZER  
(FEMALE CUTTING)**

JACKET SIZE CHART

SIZE	SHOULDER	CHEST	SLEEVE	LENGTH
155/XS	14.2"	33"	22"	21.9"
160/S	14.6"	35"	22"	21.9"
165/M	15"	37"	22.4"	22.6"
170/L	15.4"	38"	22.8"	23.4"
175/XL	15.7"	39"	23.2"	24.2"
180/2XL	16.1"	41"	23.6"	25"
185/3XL	16.5"	43"	23.6"	25"
190/4XL	16.9"	44"	23.6"	25"

Note: Size may varies +/-5% from the above mentioned chart.



SKT0202  
BLACK

SKT0203  
NAVY BLUE

SKIRT SIZE CHART

SIZE	WAIST	HIP	LENGTH
155/XS	23.6"	33.9"	37.8"
160/S	25.2"	35.4"	39.0"
165/M	26.8"	37.0"	40.2"
170/L	28.3"	38.6"	41.3"
175/XL	29.9"	40.2"	42.5"
180/2XL	31.5"	41.7"	43.7"
185/3XL	33.1"	43.3"	43.7"
190/4XL	34.6"	44.9"	43.7"

Note: Size may varies +/-5% from the above mentioned chart.



Classic Button Down  
Back Pocket

Elastic Waist Band  
Design





**CUSTOMIZATION**  
WITH ULTIFRESH TECHNOLOGY



### ULTIFRESH CUSTOMIZATION

Create your very own anti-bacterial & anti-odor apparels from scratch with 8-steps customization process! A perfect alternative for brands or institution who wish to incorporate our unique technology to their new or existing apparels design.

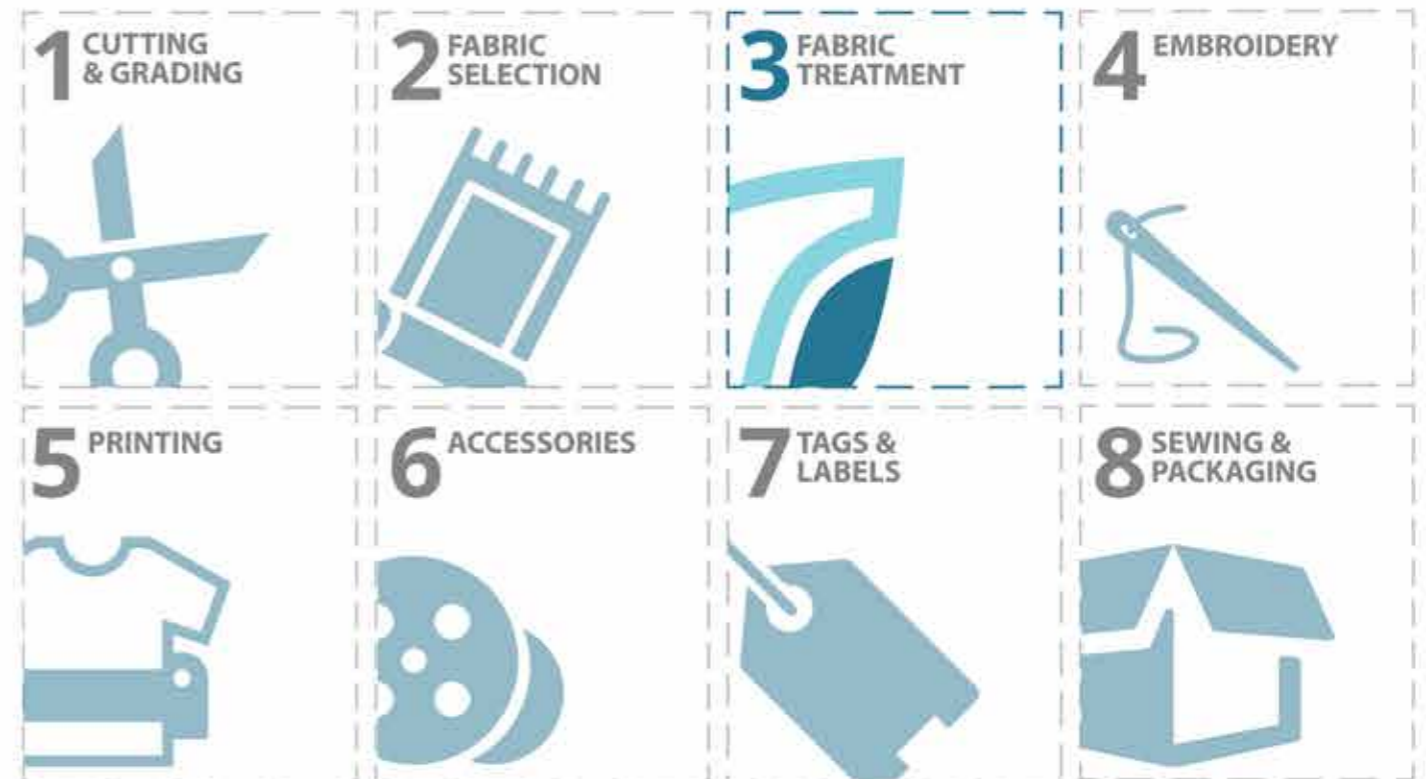



STYLES: POLO T-SHIRT



STYLES: POLO T-SHIRT



STYLES: SLEEVES

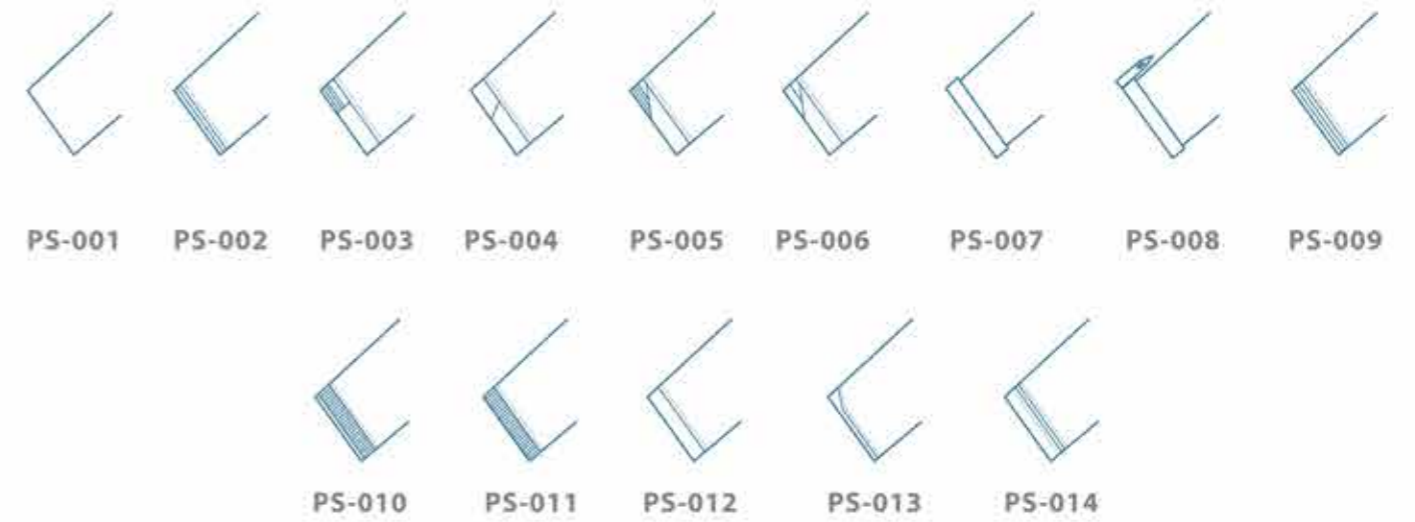

STYLES: COLLAR

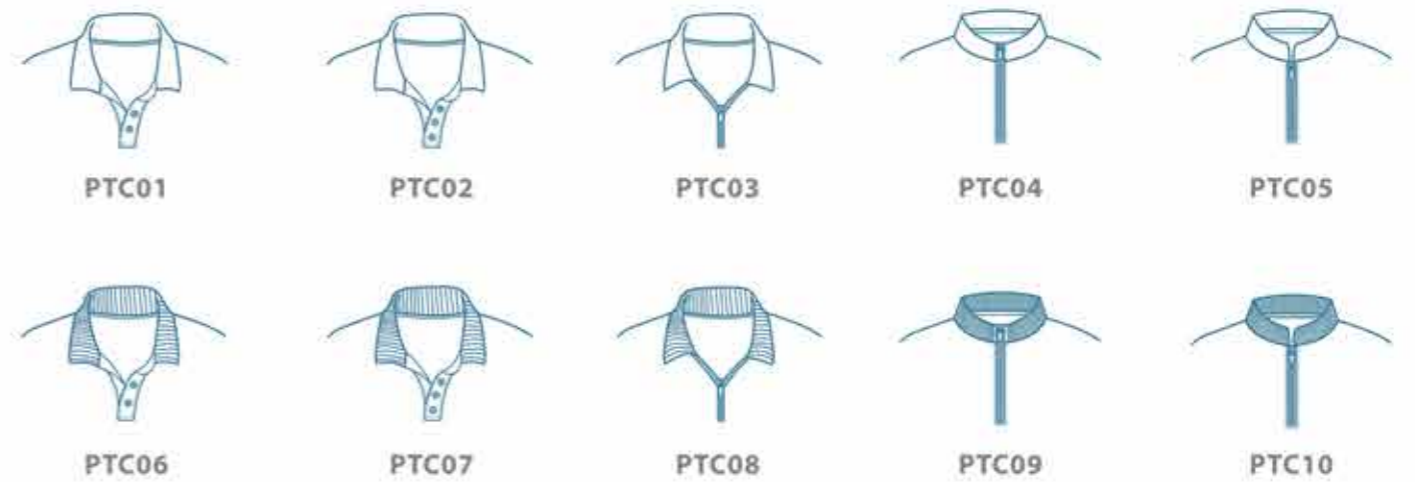



STYLES: POCKETS

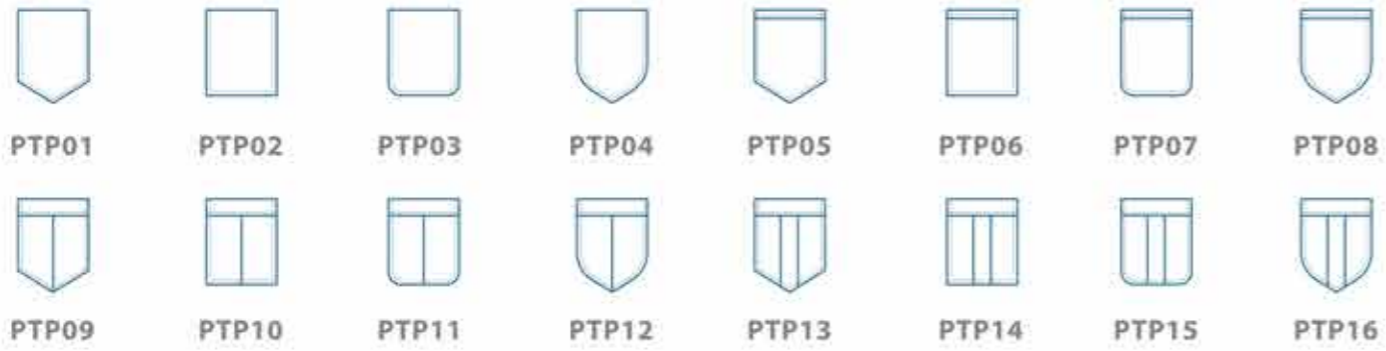

STYLES: JACKETS



STYLES: JACKETS (BACK)



STYLES: COLLAR



STYLES: SLEEVES

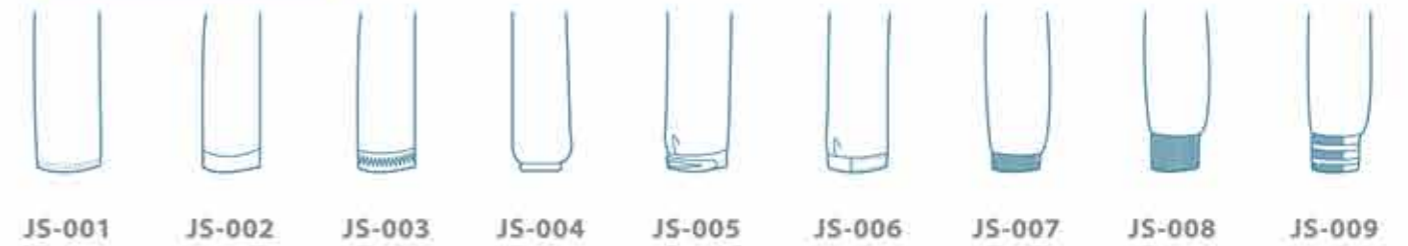

STYLES: POCKETS





STYLES: BUTTONS

\*\* FOR POLO / SHIRT ONLY \*\*



STYLES: ZIPPER HEAD

